

# Tripp Lite Network-Grade Power Distribution Units (PDUs)

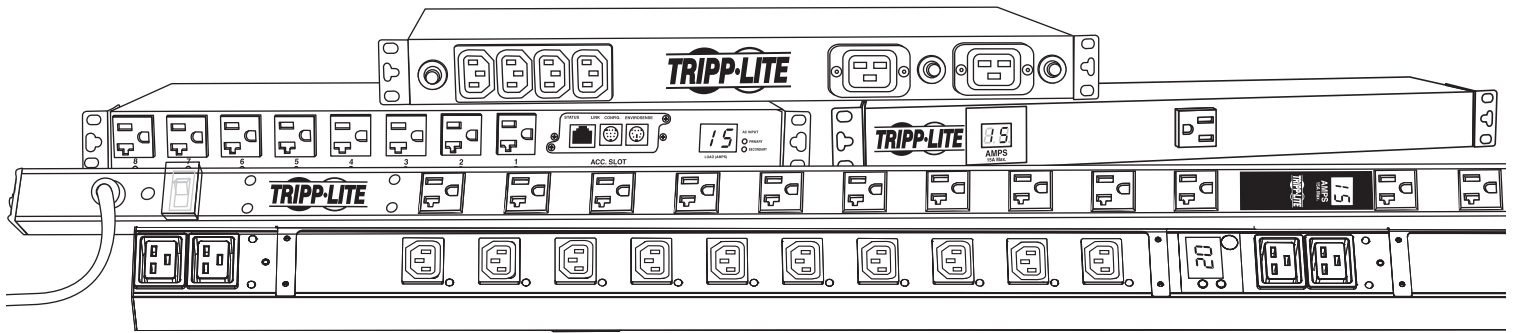

Tripp Lite Network-Grade PDUs are highly reliable multiple-outlet strips that distribute power from a UPS system, generator or utility wall outlet to multiple devices. Tripp Lite offers three separate types of rackmount PDUs (see selector guide, below) with features and benefits to match every application—networking, server, telecom and more.



## PDU Selector Guide (Features/Benefits)

Choose a PDU by identifying the ideal features and benefits for your application.

		Tripp Lite PDUs		
Feature	Benefit	Basic PDUs <i>See page 4</i>	Metered PDUs <i>See page 5</i>	Switched PDUs <i>See pages 6-7</i>
<b>Multiple Outlets</b>	Increase the number of devices that can be powered by a UPS system, generator or utility source.	✓	✓	✓
<b>High-Current Plug and Low-Current Outlets*</b>	Increase connection flexibility by converting a single high-amperage outlet into multiple low-amperage outlets.	✓	✓	✓
<b>Long Input Power Cord</b>	Increases installation flexibility by allowing devices to be located far from an input power source.	✓	✓	✓
<b>Digital Load Meter</b>	Avoid overloads and safely add loads as total equipment power consumption is displayed.		✓	✓
<b>Remote Control of Individual Outlets (via SNMP, Web or Telnet)</b>	Reduces frequency of costly service calls by rebooting locked devices. Extends runtime of critical devices by turning off nonessential loads during blackouts.			✓
<b>Remote monitoring and condition reporting</b>	Prevents overloads that cause equipment downtime.			✓

\* Select models.









### Feature Focus (See page 8)

- PDUs with Redundant Input Cords and Automatic Transfer Switch (ATS)
- PDUs with Dual Input Cords and Dual Independent Power Circuits

*See inside for an additional selector guide, application diagrams and complete specifications*

# PDU Selector Guide (Input/Output)

Choose by matching power source input to PDU output.

Step 1 Choose Power Source Input			Step 2 Choose PDU Output								
Receptacle Type	Voltage	Current	Basic PDUs			Metered PDUs			Switched PDUs		
			Model Number	Outlet Qty.	Outlet Type*	Model Number	Outlet Qty.	Outlet Type*	Model Number	Outlet Qty.	Outlet Type*
	100-125V	15A	PDU1215	13	5-15R	PDUMH15	13	5-15R	PDUMH15ATNET**	8	5-15R
			PDU1415	14	5-15R	PDUMV15	16	5-15R	PDUMV15NET	16	5-15/20R
			PDU1415	14	2 C19 / 12 C13	PDUMH15AT**	8	5-15R			
			PDUV15	12	5-15R						
	100-125V	20A	PDU1220	13	5-15/20R	PDUMV20	20	5-15/20R	PDUMH20ATNET**	16	5-15/20R
			PDU1415	14	2 C19 / 12 C13	PDUMV40	32	5-15/20R	PDUMV20NET	24	5-15/20R
			PDU40TDUAL	40	5-15/20R	PDUMH20AT**	16	5-15/20R			
			PDUV20	12	5-15/20R	PDUMH20	13	5-15/20R			
	100-125V	20A	PDU1220T	13	5-15/20R	PDUMV20	20	5-15/20R	PDUMH20ATNET**	16	5-15/20R
			PDU1420T	14	5-15/20R	PDUMV40	32	5-15/20R	PDUMV20NET	24	5-15/20R
			PDU40TDUAL	40	5-15/20R	PDUMH20AT**	16	5-15/20R			
			PDU1420T	14	2 C19 / 12 C13	PDUMH20	13	5-15/20R			
	100-125V	30A	PDU2430	24	5-15R	PDUMV30	28	5-15/20R	PDUMV30NET	24	5-15/20R
								PDUMH30NET	16	5-15/20R	
	200-250V	20A	PDU1415	14	2 C19 / 12 C13	PDUMV20HV	38	6 C19 / 32 C13	PDUMV20HVNET	24	4 C19 / 20 C13
			PDUV20	12	5-15/20R						
	200-250V	30A	PDU1230	18	2 C19 / 16 C13	PDUMV30HV	30	6 C19 / 24 C13	PDUMV30HVNET	24	4 C19 / 20 C13
			PDUV30HV	38	6 C19 / 32 C13	PDUMH30HVNET	16	C13			
	Varies	Varies	PDU1415	14	2 C19 / 12 C13	<b>PDU Part Number Decoder</b>			PDUMH15HVNET	8	C13
			PDUV15	12	5-15R	PDU = Power Distribution Unit M = Metered H = Horizontal V = Vertical AT = ATS with Redundant Input Cords NET = Network Card for Remote Monitoring and Control HV = High Voltage (200-250V)			PDUMH20HVNET	8	C13
	Varies	Varies	PDU1415	14	2 C19 / 12 C13	PDUMV20HVNET†	24	4 C19 / 20 C13	PDUMV20HVNET	24	4 C19 / 20 C13
			PDUV15	12	5-15R	PDUMH15ATNET***	8	5-15R	PDUMH20ATNET***	16	5-15/20R
VARIES (User provides C19 or C13, depending on model, to the input plug of their choice.)	Varies	Varies	PDU12IEC	14	2 C19 / 12 C13						

\* 5-20R wall outlets and 5-15/20R PDU outlets accept 5-15P or 5-20P plugs. \*\* Model includes ATS. † User provides input cable for this application.

## Using a Tripp Lite UPS System as Power Source Input

The most common application for a PDU is to distribute UPS System power to connected computer equipment. The table below shows common outlet types and a partial list of Tripp Lite UPS Systems that include each outlet type.

OUTLET TYPE	SMARTPRO UPS SYSTEMS	SMARTONLINE UPS SYSTEMS
5-15R	All 500-3000VA (120V)	All 750-3000VA (120V)
5-15/20R	All 2200-5000VA (120V)	All 2200VA-16kVA (120V)
L5-20R	Select 2200-2600VA (120V)	All 2200VA (120V)
L5-30R	All 3000VA (120V)	All 3000VA (120V)
L6-20R	Select 5000VA	All 5000VA and Select 6-16kVA
L6-30R	All 5000VA	All 5000VA and Select 6-16kVA
C13	All International Versions	All International Versions
C19	All 2200-5000VA International Versions	All 2200-3000VA International Versions

## Tripp Lite Power Cords and Adapters

Model	Description
P002-002	C14 to 5-15R Power Cable (2 ft.)
P004-006	C13 to C14 Power Cable (6 ft.)
P005-010	Heavy-Duty C13 to C14 Power Cable (10 ft.)
P006-006	C13 to 5-15P Power Cable (6 ft.)
P007-010	Heavy-Duty C13 to 5-15P Power Cable (10 ft.)
P010-012	C13 to 5-15P Power Cable (12 ft.)
P022-001	5-15R to 5-15P Power Cable (1 ft.)
P032-007	C13 to C20 Power Cable (7 ft.)
P034-010	Heavy-Duty C19 to 5-15P Power Cable (10 ft.)
P040-010	C19 to L6-20P Power Cable (10 ft.)
P044-061	L5-20R to 5-20P Adapter (6 in.)
P045-010	Heavy-Duty C19 to L5-20P Power Cable (10 ft.)
P047-010	Heavy-Duty C14 to C19 Power Cable (10 ft.)
P049-010	Heavy-Duty C19 to 5-20P Power Cable (10 ft.)
UNIPUGINT	C13 to Wonpro Universal Outlet Adapter (Wonpro outlet is compatible with more than 20 North American and international plug types.)

# PDU Application Diagrams

Tripp Lite PDUs can be used in a variety of applications. The most popular applications are shown below. Contact Tripp Lite's technical support department at (773) 869-1234 for additional assistance with a specific application.

## Application #1: Adding More Outlets to a UPS System

**Applicable Tripp Lite PDUs: All Models**

Description: **1** PDU plugs into UPS system outlet. **2** PDU increases total number of outlets powered by the UPS system (from 6 to 18 in this example. Additional front panel outlet not shown.).

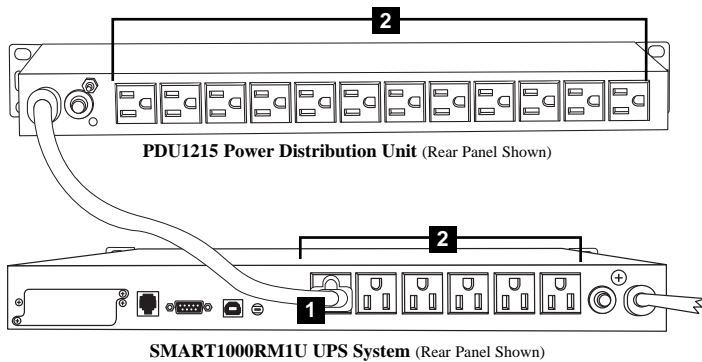

## Application #2: Converting a Single High-Amperage Outlet into Multiple Low-Amperage Outlets

**Applicable Tripp Lite PDUs: Models with High-Amperage Plugs**

Description: **1** PDU plugs into UPS system's high-amperage outlet (30-amp L5-30R outlet in this example). **2** PDU increases total number of low-amperage outlets powered by the UPS system (from 8 to 32 in this example; additional 12 front panel outlets not shown).

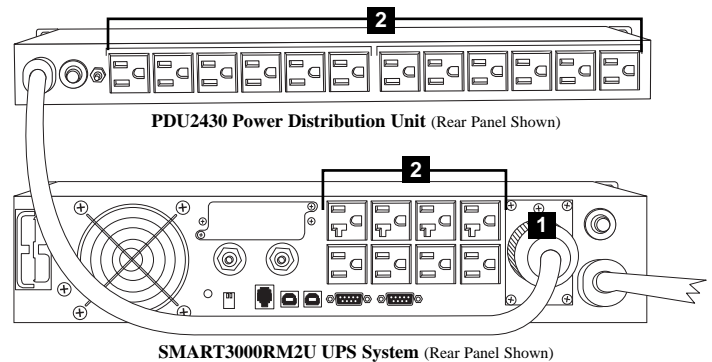

## Application #3: Remotely Controlling Individual Outlets (via SNMP, Web or Telnet)

**Applicable Tripp Lite PDUs: All Switched Models**

Description: **1** PDU's Ethernet port connects to network wall jack. **2** Remote user controls power to PDU outlets for a variety of purposes. Benefits include rebooting locked devices to reduce the frequency of costly service calls and turning off nonessential loads during blackouts to extend battery backup runtime for critical devices.

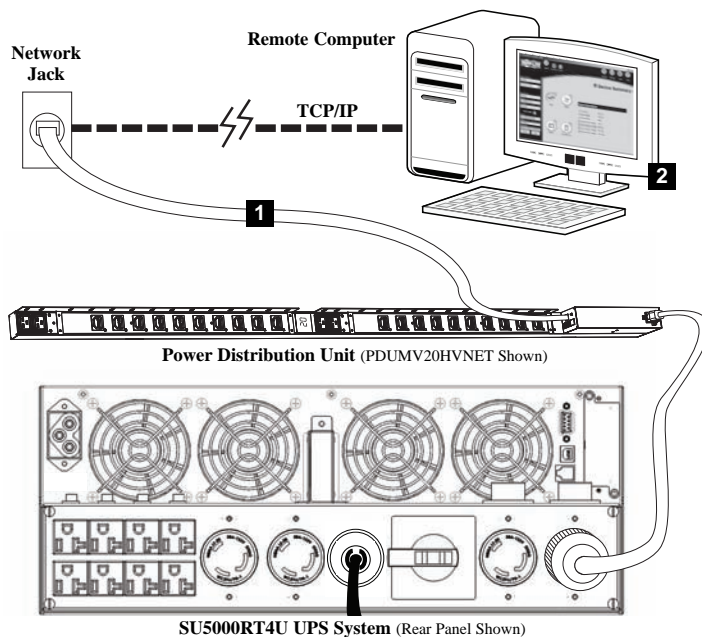

## Application #4: Distributing Facility UPS/Generator Power to Multiple Outlets

**Applicable Tripp Lite PDUs: All Models**

Description: **1** PDU plugs into a wall outlet supported by facility UPS/generator power. **2** PDU distributes power to equipment via 16 outlets. (All PDU models support facility UPS/generator applications, including all available PDU features.)

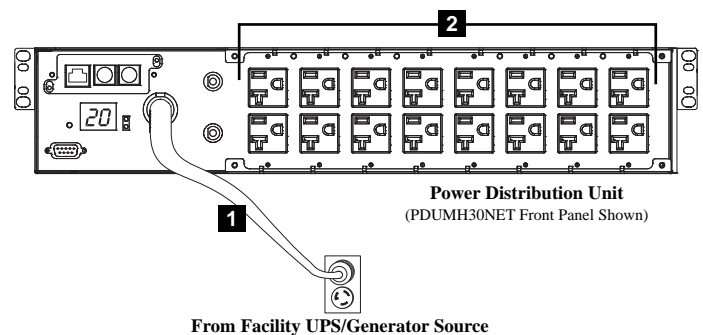

# Basic PDUs

- ✓ Multiple Outlets
- ✓ Long Input Power Cord

- ✓ All-Metal Cabinet with Versatile Mounting Options

Tripp Lite Basic PDUs reliably distribute AC power from a UPS system, generator or utility wall outlet to multiple devices. Basic PDUs offer high-quality plug/outlet connections and a switch-free design to prevent the PDU from being accidentally disconnected or shut down. Versatile all-metal cabinets with detachable mounting hardware accommodate a variety of mounting options: wallmount, under-counter and 19-inch rackmount mounting in 1U and/or zero-U formats\*. Basic PDUs are available in a variety of capacities from 15A to 30A. The PDUNV model features multiple detachable plugs to connect the PDU to a variety of outlets. The PDU40TDUAL model features two separate power circuits (with corresponding color-coded power cord, circuit breaker and outlets), making it ideal for servers with redundant power supplies and other equipment in loaded racks.

\* See specifications for mounting options supported by each model.

## FEATURES

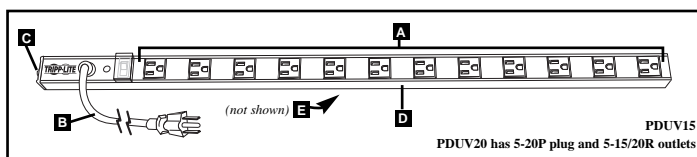
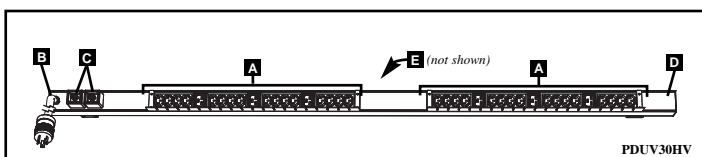
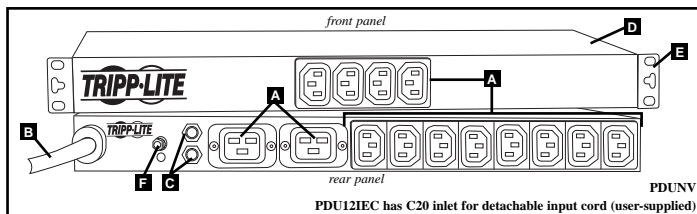
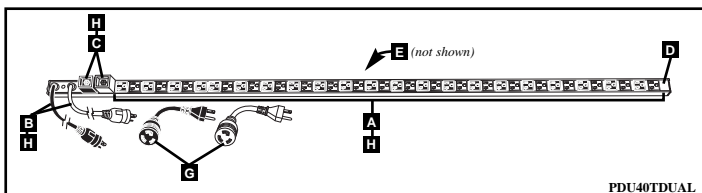
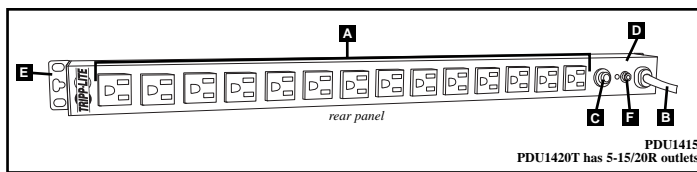
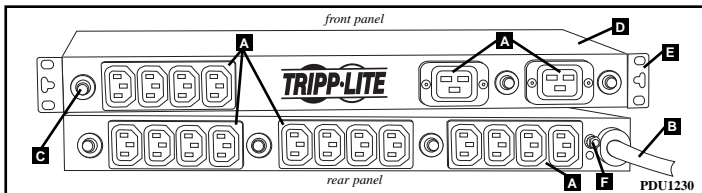
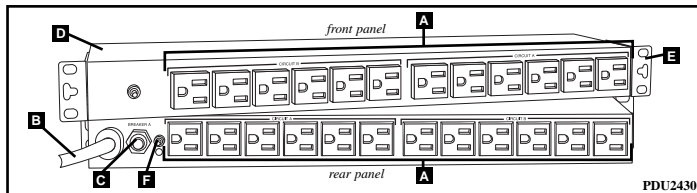
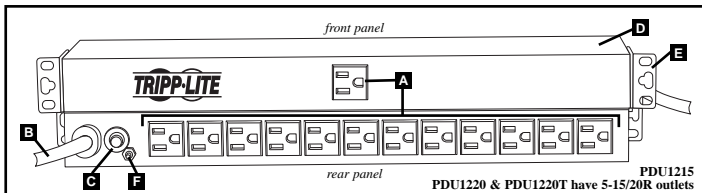

- A** Multiple High-Quality Outlets
- B** Long Input Cord with High-Quality Input Plug
- C** AC Circuit Breaker Protection
- D** Rugged All-Metal Housing
- E** Secure Mounting Hardware
- F** Grounding Lug
- G** Twist-Lock L5-20P to Straight-Blade 5-20P Plug Adapters
- H** Dual Circuits

## SPECIFICATIONS

Model	Input Voltage	Maximum Input Current	Breakers	Input Plug Type	Outlet Qty. & Type <sup>(a)</sup>	Front Outlets	Rear Outlets	Input Cord Length	Unit Dimensions (H x W x D, in)	1U Rackmount	0U Vertical Mount	Wallmount/ Under Counter Mount
PDU1215	120V	15A	1 x 15A	5-15P	13 (5-15R)	1	12	15 ft.	1.75 x 17.5 x 4.5	✓	✓	✓
PDU1220	120V	20A	1 x 20A	5-20P	13 (5-15/20R)	1	12	15 ft.	1.75 x 17.5 x 4.5	✓	✓	✓
PDU1220T	120V	20A	1 x 20A	L5-20P	13 (5-15/20R)	1	12	15 ft.	1.75 x 17.5 x 4.5	✓	✓	✓
PDU2430	120V	30A	2 x 15A	L5-30P	24 (5-15R)	12	12	15 ft.	1.75 x 17.5 x 4.5	✓	✓	✓
PDU1230	208/240V	30A	2 x 15A, 4 x 10A	L6-30P	18 (2 C19 / 16 C13)	4 C13 / 2 C19	12 C13	15 ft.	1.75 x 17.5 x 5.25	✓	✓	✓
PDU1415	120V	15A	1 x 15A	5-15P	14 (5-15R)	n/a	14	15 ft.	1.75 x 25.75 x 2.25	n/a	✓	✓
PDU1420T	120V	20A	1 x 20A	L5-20P	14 (5-15/20R)	n/a	14	15 ft.	1.75 x 25.75 x 2.25	n/a	✓	✓
PDU40TDUAL	120V	2 x 20A	2 x 20A	L5-20P / 5-20P (2) <sup>(b)</sup>	40 (5-15/20R)	40	n/a	2 x 10 ft.	3 x 71 x 1.5	n/a	✓	✓
PDUNV	100-250V	16A	2 x 16A	Supports 6 plugs <sup>(c)</sup>	14 (12 C13 / 2 C19)	4 C13	8 C13 / 2 C19	10 ft.	1.75 x 17.5 x 4.25	✓	✓	✓
PDU12IEC	100-250V	16A	2 x 16A	C20 inlet (no cord) <sup>(d)</sup>	14 (12 C13 / 2 C19)	4 C13	8 C13 / 2 C19	n/a	1.75 x 17.5 x 4.25	✓	✓	✓
PDUV15	120V	15A	1 x 15A	5-15P	12 (5-15R)	12	n/a	15 ft.	1.75 x 36 x 1.25	n/a	✓	✓
PDUV20	120V	20A	1 x 20A	5-20P	12 (5-15/20R)	12	n/a	15 ft.	1.75 x 36 x 1.25	n/a	✓	✓
PDUV30HV	208V	30A <sup>(a)</sup>	2 x 15A	L6-30P	38 (32 C13 / 6 C19)	38	n/a	10 ft.	3.5 x 63.75 x 2.25	n/a	✓	✓

<sup>(a)</sup> Code-rated maximum input current is 80% of value shown.

<sup>(b)</sup> PDU40TDUAL is a two-corded, dual-circuit PDU in a vertical strip format with (2) twist-lock L5-20P plugs and (2) adapters to support connection to straight-blade 5-20R outlets.

<sup>(c)</sup> PDUNV includes a C20 input plug, plus 5 adapters which terminate in C14, 5-15P, 5-20P, L5-20P or L6-20P.

<sup>(d)</sup> PDU12IEC has a C20 power inlet. User must supply input cord with C19 connection to attach to the PDU, and any plug type to connect to a utility source. <sup>(b)</sup> 5-15/20R outlets accept 5-15P or 5-20P plugs.

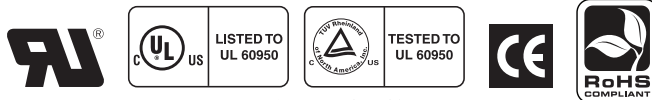

Certifications vary by model.

# Metered PDUs

- ✓ Digital Load Meter(s)
- ✓ Multiple Outlets
- ✓ Long Input Power Cord

- ✓ All-Metal Cabinet with Versatile Mounting Options

Tripp Lite Metered PDUs reliably distribute AC power from a UPS system, generator or utility wall outlet to multiple devices. Each model features a digital load meter that helps you maximize the amount of devices that can be safely added to the PDU (without overloading it) by displaying the total power consumption of connected equipment. Metered PDUs offer high-quality plug/outlet connections and a switch-free or switch-protected design to prevent the PDU from being accidentally disconnected or shut down. Versatile all-metal cabinets with detachable mounting hardware accommodate a variety of mounting options:\* wallmount, under-counter and 19-inch rackmount mounting in 1U and/or zero-U formats. Metered PDUs are available in 15A, 20A, 30A and 40A capacities. The PDUMV40 model features two separate 20-amp power circuits (with corresponding color-coded power cord, circuit breaker, load meter and outlets), making it ideal for servers with redundant power supplies and other equipment in loaded racks. The PDUMV30 model includes high-current 120V input with two banks of outlets and dual meters. The PDUMV20HV model includes 208/230V input with C13 and C19 outlets. The PDUMV30HV model includes 208V input with two banks of C13 and C19 outlets and dual meters. The PDUMV30, PDUMV20HV and PDUMV30HV models also include plug retention brackets that hold connected equipment cables in place. The PDUMH15AT and PDUMH20AT models include redundant inputs with Automatic Transfer Switching (see page 8 for more information) and are user-upgradeable to switched PDUs (requires SNMPWEBCARD, sold separately).

\* See specifications for mounting options supported by each model.

## FEATURES

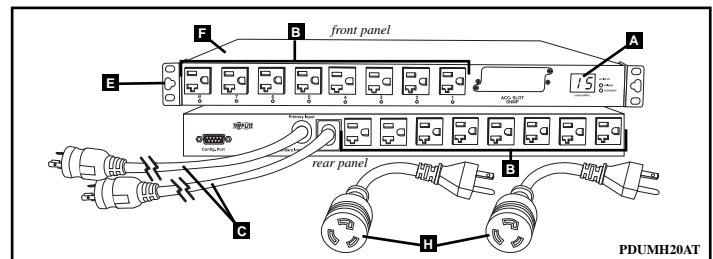
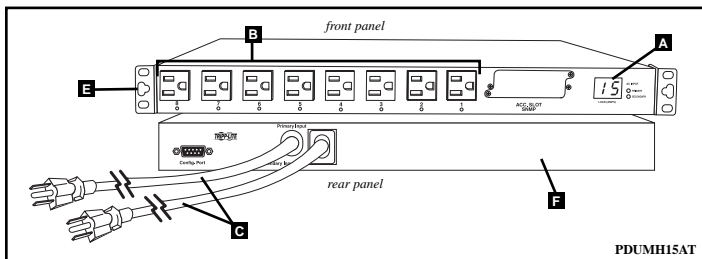
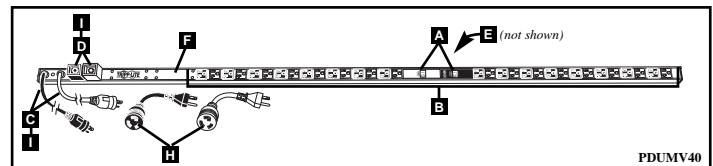
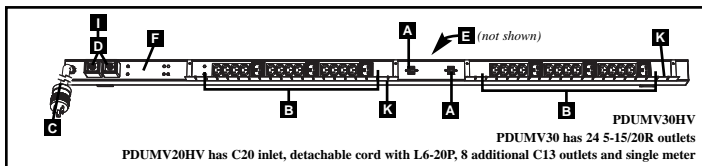
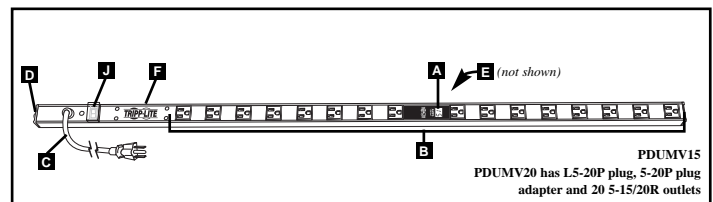
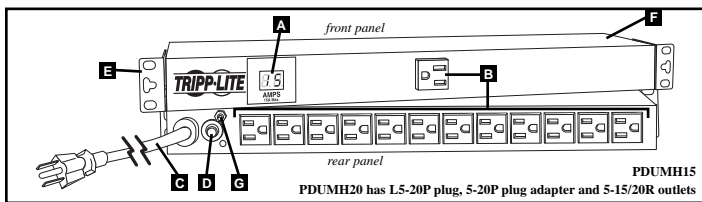

- A** Digital Load Meter
- B** Multiple High-Quality Outlets
- C** Long Input Cord with High Quality Input Plug
- D** AC Circuit Breaker Protection
- E** Secure Mounting Hardware
- F** Rugged All-Metal Housing
- G** Grounding Lug
- H** Twist-Lock L5-20P to Straight-Blade 5-20P Plug Adapter
- I** Dual Circuits
- J** Lighted Power Switch with Safety Cover
- K** Cord Retention Bracket

## SPECIFICATIONS

Model	Input Voltage	Maximum Input Current	Meters	Input Plug Type	Outlet Qty. & Type <sup>(a)</sup>	Front Outlets	Rear Outlets	Input Cord Length	Unit Dimensions (H x W x D, in)	1U Rackmount	0U Vertical Mount	Wallmount/ Under Counter Mount
PDUMH15	120V	15A	1 x 15A	5-15P	13 (5-15R)	1	12	15 ft.	1.75 x 17.5 x 4.5	✓	✓	✓
PDUMH20	120V	20A	1 x 20A	L5-20P / 5-20P <sup>(c)</sup>	13 (5-15/20R)	1	12	15 ft.	1.75 x 17.5 x 4.5	✓	✓	✓
PDUMV15	120V	15A	1 x 15A	5-15P	16 (5-15R)	16	n/a	15 ft.	1.5 x 48 x 1.5	n/a	✓	✓
PDUMV20	120V	20A	1 x 20A	L5-20P / 5-20P <sup>(c)</sup>	20 (5-15/20R)	20	n/a	15 ft.	1.75 x 60 x 1.25	n/a	✓	✓
PDUMV40	120V	2 x 20A	2 x 20A	L5-20P / 5-20P (2) <sup>(d)</sup>	32 (5-15/20R)	32	n/a	2 x 10 ft.	3 x 71.25 x 1.5	n/a	✓	✓
PDUMH15AT	120V <sup>(a)</sup>	15A	1 x 15A	5-15P	8 (5-15R)	8	n/a	2 x 12 ft.	1.75 x 17.5 x 14.5	✓	✓	✓
PDUMH20AT	120V <sup>(a)</sup>	20A	1 x 20A	L5-20P / 5-20P <sup>(c)</sup>	16 (5-15/20R)	8	8	2 x 12 ft.	1.75 x 17.5 x 14.5	✓	✓	✓
PDUMV30	120V	30A <sup>(b)</sup>	2 x 20A	L5-30P	24 (5-15/20R)	24	n/a	10 ft.	3.75 x 63.75 x 2.25	n/a	✓	✓
PDUMV20HV	208/230V	20A <sup>(b)</sup>	1 x 20A	L6-20P (C20 inlet)	38 (32 C13 / 6 C19)	38	n/a	10 ft.	3.75 x 63.75 x 2.25	n/a	✓	✓
PDUMV30HV	208V	30A <sup>(b)</sup>	2 x 15A	L6-30P	30 (24 C13 / 6 C19)	30	n/a	10 ft.	3.5 x 63.75 x 2.25	n/a	✓	✓

<sup>(a)</sup> Primary input (fixed cord) tolerances: 99-138V, 45-65Hz. Outside of this range, the PDU switches to the secondary input (detachable cord) if within 99-138V range.

Two front panel LEDs marked "primary" and "secondary" indicate the active input source.

<sup>(b)</sup> Code-derived maximum input current is 80% of value shown.

<sup>(c)</sup> Includes a twist-lock L5-20P input plug and an adapter to support connection to a straight blade 5-20R outlet. PDUMH20AT includes (2) cords with twist-lock L5-20P input plugs and (2) adapters to support connection to straight-blade 5-20R outlets.

<sup>(d)</sup> PDUMV40 is a two-corded, dual-circuit PDU with (2) twist-lock L5-20P plugs and (2) adapters to support connection to straight-blade 5-20R outlets.

<sup>(e)</sup> 5-15/20R outlets accept 5-15P or 5-20P plugs.

Tripp Lite World Headquarters 1111 W. 35th Street, Chicago, IL 60609 USA • (773) 869-1234 • www.tripplite.com



Certifications vary by model.



# Switched PDUs

- ✓ Remote Control of Individual Outlets
- ✓ Remote Monitoring and Condition Reporting
- ✓ Digital Load Meter(s)
- ✓ Multiple Outlets

- ✓ Long Input Power Cord
- ✓ All-Metal Cabinet with Versatile Mounting Options

Tripp Lite Switched PDUs reliably distribute AC power from a UPS system, generator or utility wall outlet to multiple devices. A built-in network interface allows users to remotely control individual outlets (and connected devices) via SNMP, Web or Telnet. This feature reduces the frequency of costly service calls by enabling remote reboot of locked devices. It can also be used to extend the runtime of critical devices by allowing users to turn off nonessential devices during a blackout. Each model features one or more digital load meters that help you maximize the amount of devices that can be safely added to the PDU (without overloading it) by displaying the total power consumption of connected equipment. High-quality plug/outlet connections and a switch-free design prevent the PDU from being accidentally disconnected or shut down. Versatile all-metal cabinets with detachable mounting hardware accommodate a variety of mounting options: wallmount, under-counter and 19-inch rackmount mounting in 1U and/or zero-U formats\*. Switched PDUs are available in 15A, 20A and 30A capacities.

\* See specifications for mounting options supported by each model.

## SPECIFICATIONS

Model	Input Voltage	Maximum Input Current	Meters	Input Plug Type	Outlet Qty. & Type <sup>(b)</sup>	Input Cord Length	Unit Dimensions (H x W x D, in)	1U or 2U Rackmount	0U Vertical Mount	Wallmount/ Under Counter Mount
<b>Horizontal Models</b>										
<b>PDUMH15ATNET</b>	120V <sup>(a)</sup>	15A	1 x 15A	5-15P	8 (5-15R)	2 x 12 ft.	1.75 x 17.5 x 14.5	1U	✓	✓
<b>PDUMH20ATNET</b>	120V <sup>(a)</sup>	20A	1 x 20A	L5-20P / 5-20P <sup>(d)</sup>	16 (5-15/20R)	2 x 12 ft.	1.75 x 17.5 x 14.5	1U	✓	✓
<b>PDUMH30NET</b>	120V	30A <sup>(b)</sup>	1 (2 x 20A) <sup>(c)</sup>	L5-30P	16 (5-15/20R)	10 ft.	3.5 x 17.5 x 12.5	2U	✓	✓
<b>PDUMH15HVNET</b>	208/230V	15A <sup>(b)</sup>	1 x 15A	C14 inlet	8 (C13)	6.5 ft.	1.75 x 17.5 x 14.75	1U	✓	✓
<b>PDUMH20HVNET</b>	208/230V	20A <sup>(b)</sup>	1 x 20A	L6-20P (C20 inlet)	8 (C13)	8.5 ft.	1.75 x 17.5 x 14.75	1U	✓	✓
<b>PDUMH30HVNET</b>	208V	30A <sup>(b)</sup>	1 (2 x 15A) <sup>(c)</sup>	L6-30P	16 (C13)	10 ft.	3.5 x 17.5 x 12.5	2U	✓	✓
<b>Vertical Models</b>										
<b>PDUMV15NET</b>	120V	15A <sup>(b)</sup>	1 x 15A	5-15P	16 (5-15/20R)	10 ft.	4.25 x 49 x 2.25	n/a	✓	✓
<b>PDUMV20NET</b>	120V	20A <sup>(b)</sup>	1 x 20A	L5-20P / 5-20P <sup>(d)</sup>	24 (5-15/20R)	10 ft.	4.25 x 63 x 2.25	n/a	✓	✓
<b>PDUMV30NET</b>	120V	30A <sup>(b)</sup>	1 (2 x 20A) <sup>(c)</sup>	L5-30P	24 (5-15/20R)	10 ft.	4.25 x 70 x 2.25	n/a	✓	✓
<b>PDUMV20HVNET</b>	208/230V	20A <sup>(b)</sup>	1 x 20A	L6-20P (C20 inlet)	24 (20 C13 / 4 C19)	10 ft.	4.75 x 64 x 2.25	n/a	✓	✓
<b>PDUMV30HVNET</b>	208V	30A <sup>(b)</sup>	1 (2 x 15A) <sup>(c)</sup>	L6-30P	24 (20 C13 / 4 C19)	10 ft.	4.75 x 70 x 2.25	n/a	✓	✓

<sup>(a)</sup> Primary input (fixed cord) tolerances: 99-138V, 45-65Hz. Outside of this range, the PDU switches to the secondary input (detachable cord) if within 99-138V range. Two front panel LEDs marked "primary" and "secondary" indicate the active input source. Includes built-in Ethernet jack with programmed and real-time remote control options via SNMP, Web or Telnet.

<sup>(b)</sup> Code-derived maximum input current is 80% of value shown.

<sup>(c)</sup> Switchable meter displays total load for PDU or for each output bank.

<sup>(d)</sup> Includes twist-lock input plug(s) and adapter(s) to support connection to a straight-blade outlet.

<sup>(e)</sup> 5-15/20R outlets accept 5-15P or 5-20P plugs.



Certifications vary by model.

## REMOTE OUTLET CONTROL APPLICATIONS

- A** Load Shedding
- B** Remote Reboot

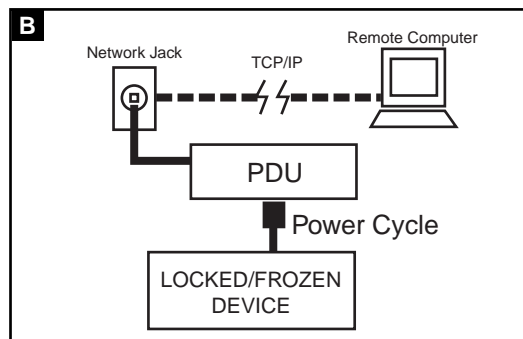
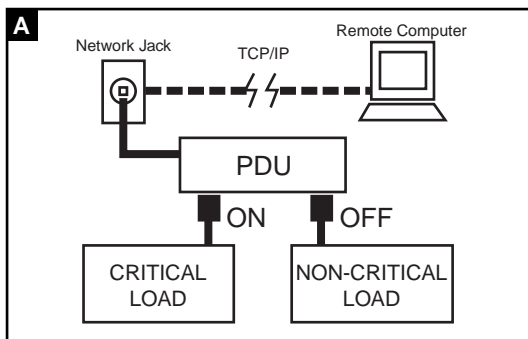

# Switched PDUs

## FEATURES

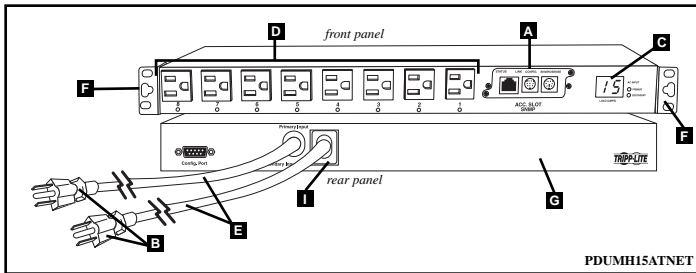

PDUH15ATNET

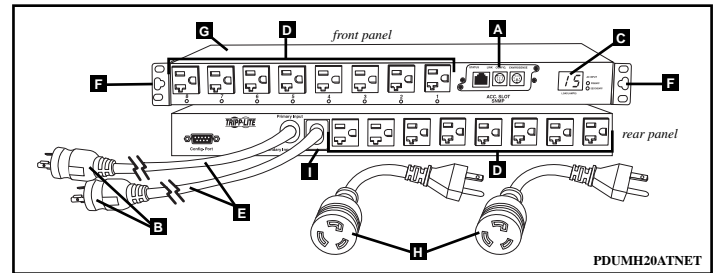

PDUH20ATNET

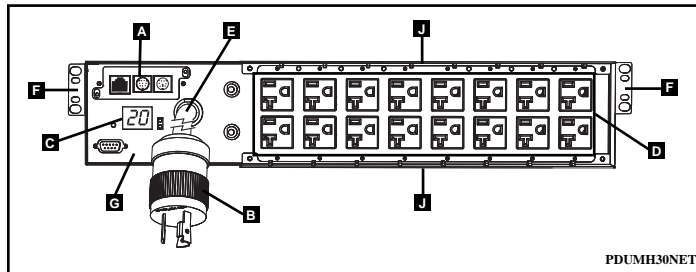

PDUH30NET

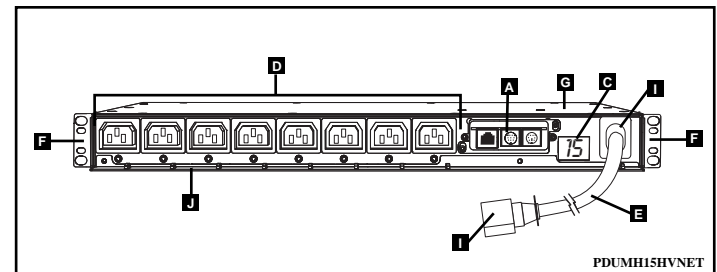

PDUH15HVNET

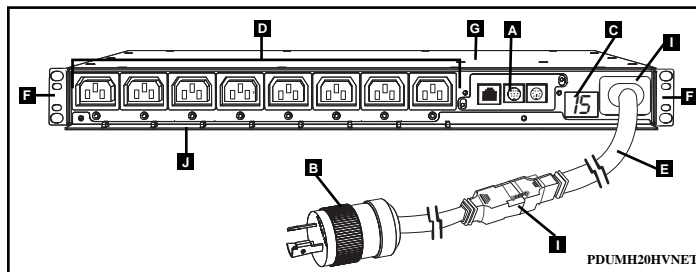

PDUH20HVNET

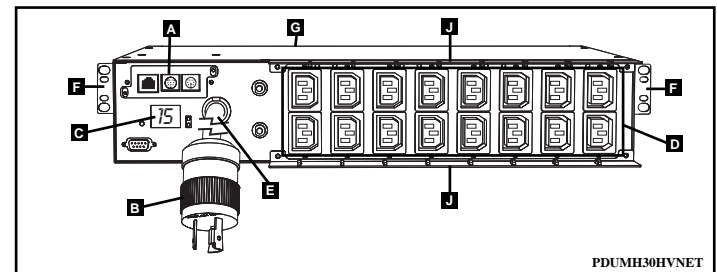

PDUH30HVNET

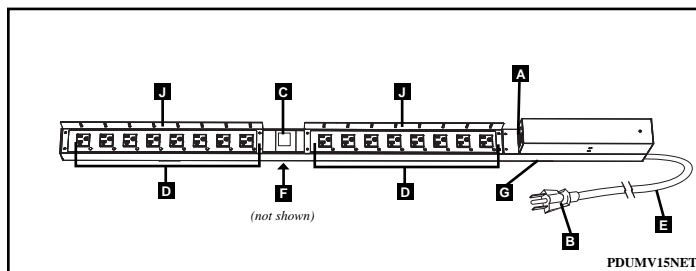

PDUMV15NET

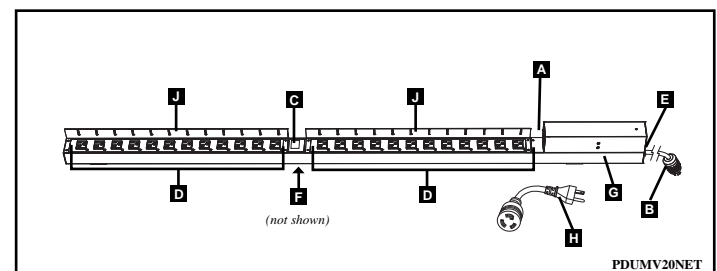

PDUMV20NET

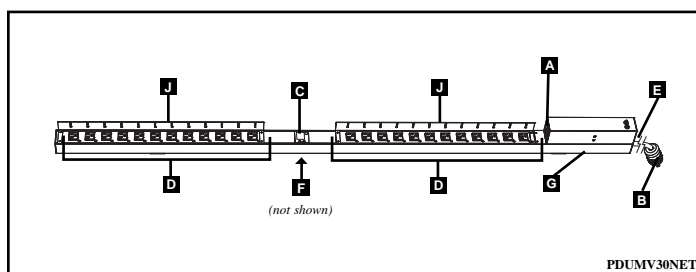

PDUMV30NET

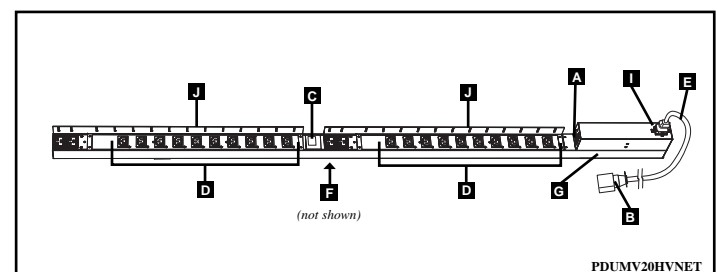

PDUMV20HVNET

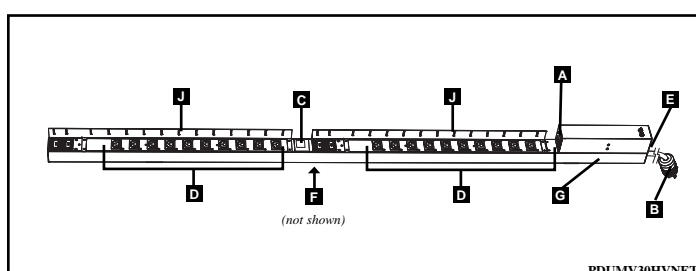

PDUMV30HVNET

- A** Network Interface for Remote Monitoring and Individual Outlet Control
- B** High-Quality Input Plug
- C** Digital Load Meter
- D** Multiple High-Quality Outlets
- E** Long Input Power Cord
- F** Secure Mounting Hardware
- G** Rugged All-Metal Housing
- H** Twist-Lock L5-20P to Straight-Blade 5-20P Plug Adapter
- I** C14 or C20 Power Inlet
- J** Cord Retention Bracket

# PDUs with Automatic Transfer Switching (ATS)

Tripp Lite PDUs with Automatic Transfer Switching (ATS) reliably distribute AC power from a UPS system, generator or utility source to multiple devices. Each model includes dual AC input plugs and an internal automatic transfer switch between available power sources. These features safeguard the uptime of connected devices by automatically providing a backup source of AC power if one source fails or is taken off-line for maintenance. The two input cords can be connected to two utility sources, two generator sources, two UPS systems or any combination of these sources.

## Providing Redundant Input Power Sources for Single-Cord Devices

**Applicable Tripp Lite PDUs: PDUMH15AT, PDUMH20AT, PDUMH15ATNET, PDUMH20ATNET**

Description: **1** PDU's primary input plugs into primary UPS system (attached to its own circuit in this example). **2** PDU's secondary input plugs into secondary UPS system (attached to its own circuit in this example). **3** PDU's internal Automatic Transfer Switch (ATS) monitors voltage and frequency levels, switching to secondary input when primary input is outside of safe operating range (99-138V and 45-65 Hz).

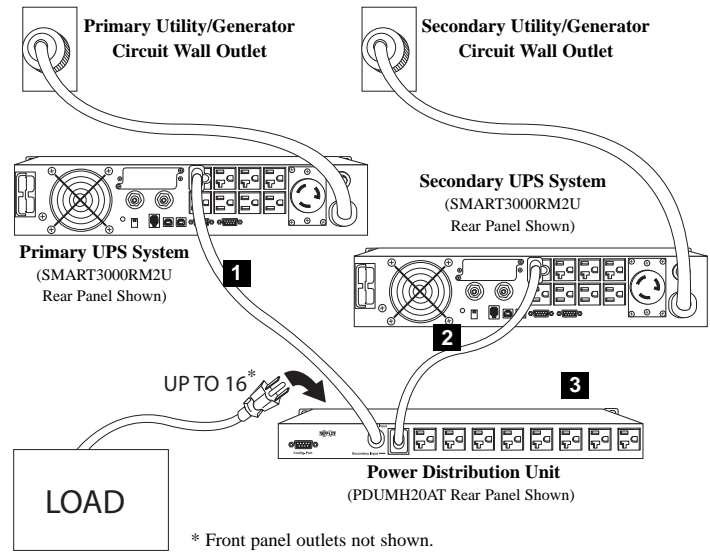

## REDUNDANT INPUT APPLICATIONS

Choose one of the following application configurations to provide redundant input (when desired).

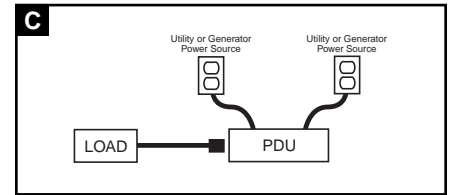
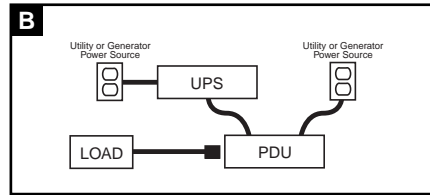
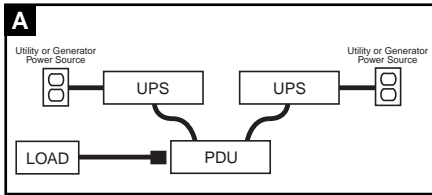

# PDUs with Dual Independent Power Circuits

Dual Independent Power Circuit PDUs provide an efficient and manageable power distribution solution for multiple servers with redundant power supplies, combining the advantages of two separate high-current PDUs without the extra expense, increased space requirements and added management complexity. Input plugs, input power cords, breakers and outlets are color-coded to match each independent circuit, allowing simplified cable management for multi-server configurations.

## Providing Independent Power Sources for Devices with Redundant Power Cords

**Applicable Tripp Lite PDUs: PDU40TDUAL, PDUMV40**

Description: **1** Each PDU input cord plugs into an independent UPS, utility and/or generator power source. **2** PDU distributes power to equipment with redundant power supplies (also appropriate for equipment without redundant power supplies), providing an independent power source for each power supply.

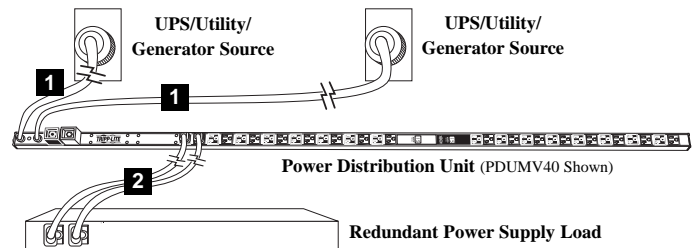

1111 W. 35th Street, Chicago, IL 60609 • (773) 869-1234 • www.tripplite.com

Copyright © 2008 Tripp Lite. All rights reserved.

The policy of Tripp Lite is one of continuous improvement. Specifications are subject to change without notice.